

MOONLIGHT

37 PENDANTS ROUND CHANDELIER

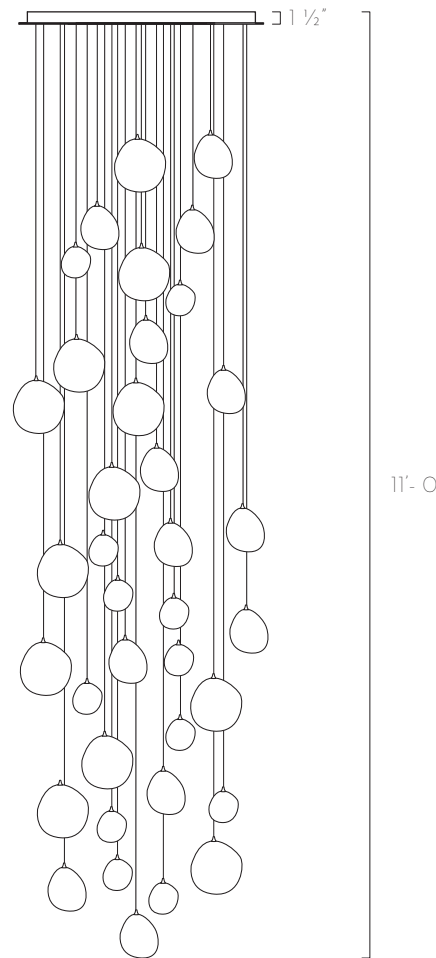
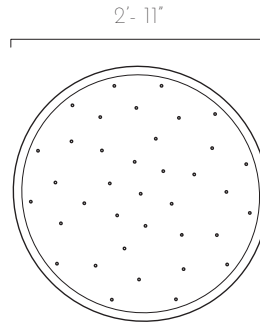

DESCRIPTION

A symbol of unparalleled beauty, originality and craftsmanship, the moonlight fixture is a handmade blown glass pendant chandelier designed by AM Studio and glass artist Karli Sears. Each globe is hand crafted with a frosted finish in white, silver, amber or bronze. Perfect lighting for Dining, Staircase, Foyer, Lobby, Reception or any commercial or residential space that require an artistic, dynamic and unique lighting statement. Pendants come in three sizes. Fixture can be fully customized based on number of pendants, sizes, colors, ceiling base and total length.

TECHNICAL SPECIFICATIONS

Designed by

Karli Sears & AM Studio

Category

Pendant Chandelier

Canopy Finish

Powder coated metal in Flat White/ Sparkle Silver

Canopy Size

35"D x 1.5"H

Pendant colours

White, Silver, Amber, Bronze

Pendant Size

12 x units of 6"D
13 x units of 4.5"D
12 x units of 3"D

Total Drop

11'H + 2' extra wire for adjustment

Bulb

Dimmable G4 LED- 2W - 12V

Recommended Dimming Switch

Lutron CTCL-153PD
Lutron Pro

Transformer:

Magnitude E60R12DC - 60W 12VDC - Dimmable -
Class 2 LED Driver
Input: 120V
Output: 12V

Electrical Outlet needed: 1

Catalogue # ML-37-35D



UL Listed



CSA Certified



Made in Canada



Note: Due to the nature of our handmade work, there may be slight variances in glass colour. AM Studio light fixtures are made to order, handmade and created in Toronto, Canada.

AM STUDIO CUSTOM LIGHTING | 80 Kincort St, Toronto | +1 (416) - 783 - 4100 | info@amstudio.ca | www.amstudio.ca

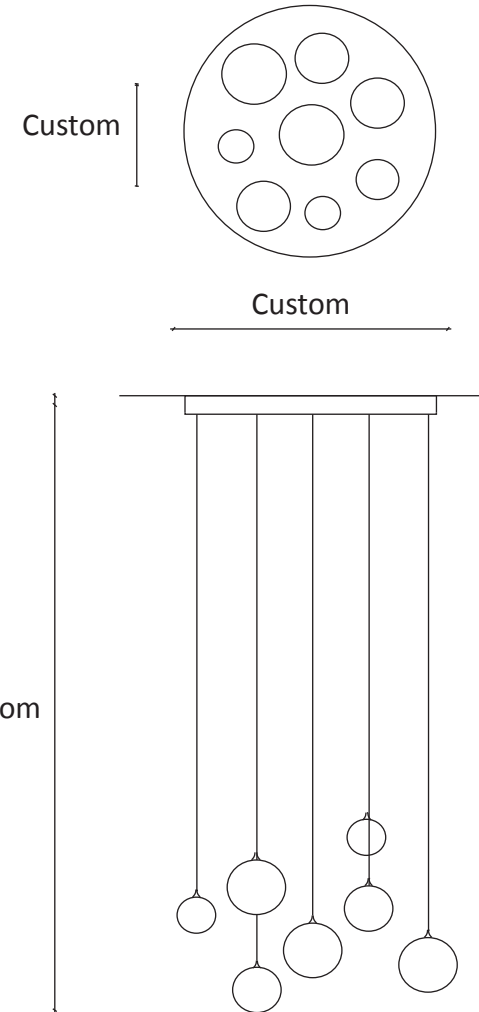
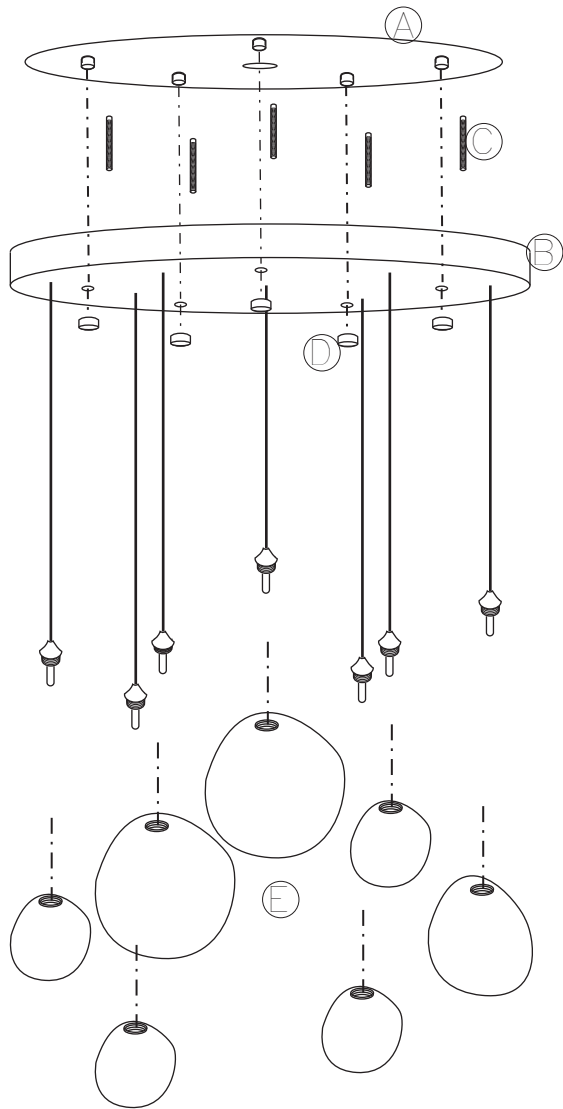

- Ⓐ x1 Bridge
- Ⓑ x1 Base
- Ⓒ x2 Support Rods (temporary mounting only)
- Ⓓ x2 Button Head Screws
- Ⓔ Glass Pendants , 3 sizes (See instructions page 3)

1.

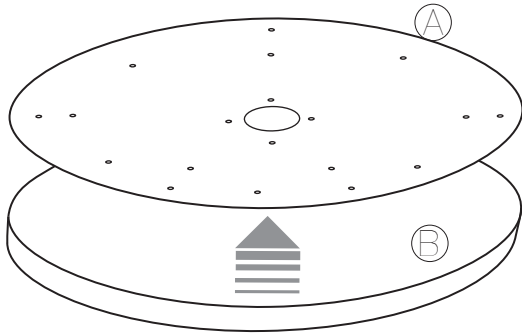

Separate (A) from (B)

4.

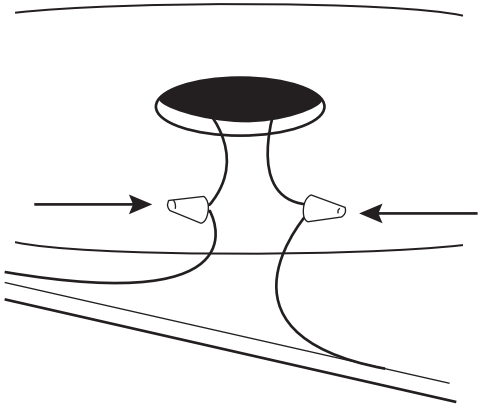

Connect electrical wire to the power

2.

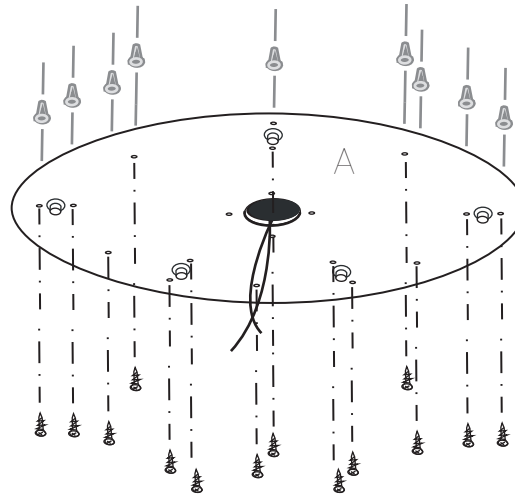

Mount (A) to the ceiling.

Note: When mounting be sure to locate and mount (A) to a joist/ceiling beam

If you cannot do so, be sure to use drywall screws and anchors, drill additional holes for mounting for better support

5.

Test lights by turning on power



Make sure bulb is not touching the glass!

Turn off power after testing

MOONLIGHTS Assembly Guide

3.

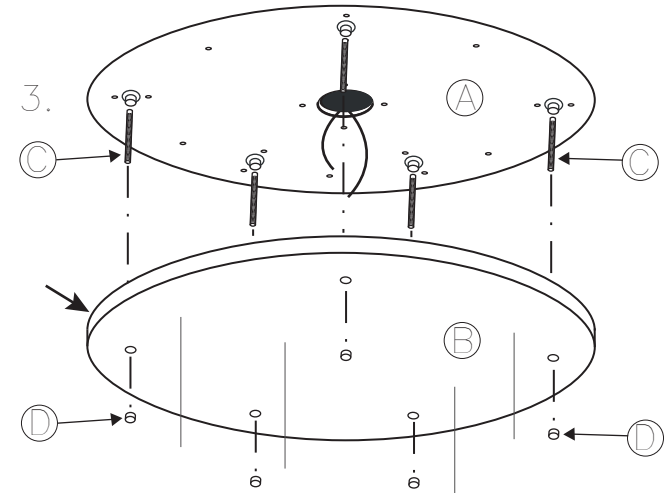

Use support rods (C) provided to hang (B) off of (A)

Complete attachment with button head screws (D)

6.

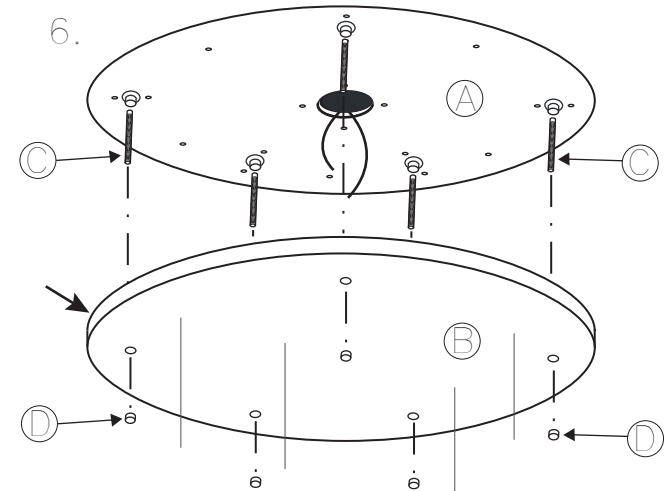

Remove rods and attach (B) to (A) with the button head screws (D)

7.

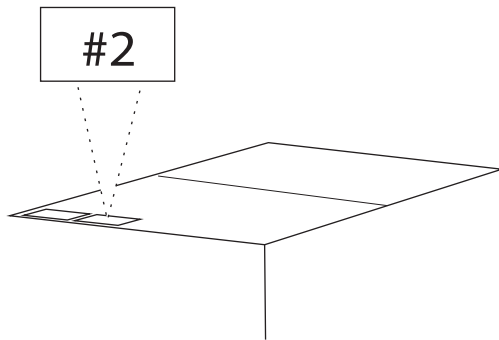

Attach pednants to cables by matching thier stickers

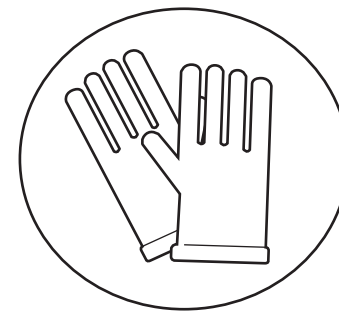
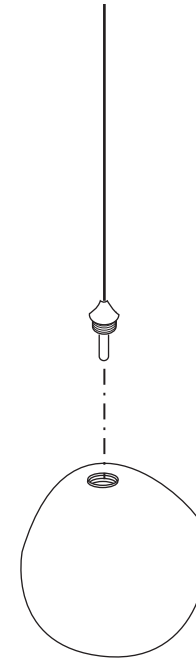
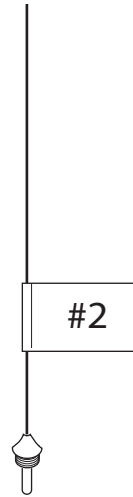

Always use gloves when handling

1.



- Dust the cord/rope/chain with a duster.

2.

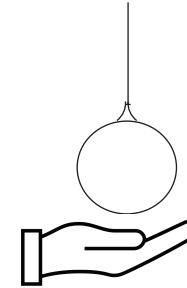

- Hold the glass pendant/light fixture and gently wipe with a duster or microfiber cloth to remove dust.

3.

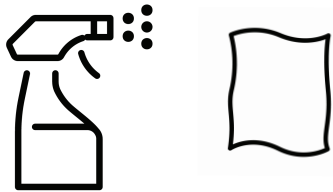

- For spot cleaning, use any good glass cleaner and a microfiber cloth.
⚠ Do **NOT** spray directly onto the light fixture/ glass pendant

4.



- Finish by gently wiping down the pendant with a soft, dry microfibre cloth.

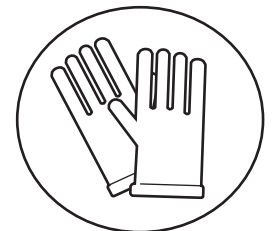

Always use gloves when handling glass